



D09 Pro Motorcycle Lights - User Manual



D09 Pro With White/Amber DRL
(3-button Switch)



D09 Pro With White&Amber DRL
(4-button Switch)

Technical Specifications

Feature / Model	D09 Pro-White&Amber DRL	D09 Pro-Amber DRL	D09 Pro-White DRL
Housing Design	4.5inch Round	4.5inch Round	4.5inch Round
Beam Types	High&Low Beam	High&Low Beam	High&Low Beam
Controls on Switch	Strobe High-Low Beam 4-Level Brightness DRL Color	Strobe High-Low Beam DRL	Strobe High-Low Beam DRL
Brightness	100%/80%/60%/40%	100%	100%
DRL Function	Dual Color DRL	Single DRL	Single DRL
DRL Color	White&Amber DRL	Amber DRL	White DRL
Wiring Harness	Yes	Yes	Yes
Connection	Waterproof 5-pin	Waterproof 4-pin	Waterproof 4-pin
Switch Type	4-button	3-button	3-button
Material Lens	Polycarbonate	Polycarbonate	Polycarbonate
Waterproof Rating	IP68	IP68	IP68

Warranty

Warranty Period: 24 months from the date of purchase

- Coverage:**
- LED failure
 - Water ingress (non-user damage)
 - Manufacturing defects

Actual performance may vary depending on installation angle, vehicle voltage, and environmental conditions.

Wiring Diagram

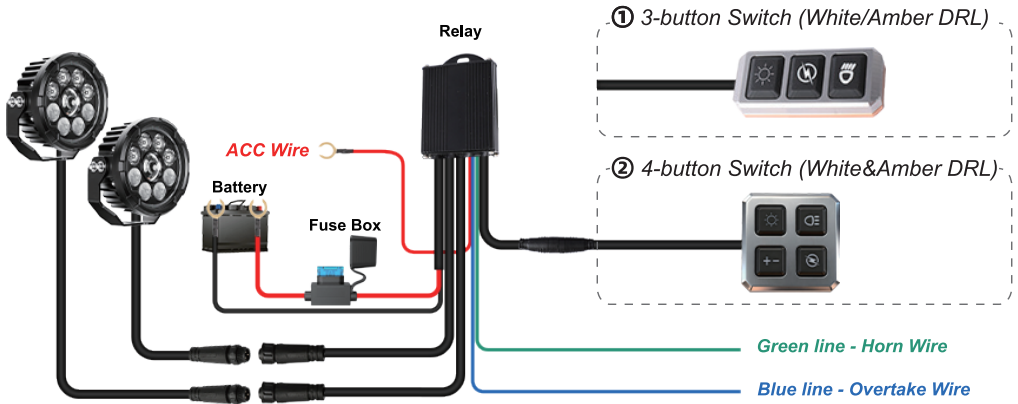

- **ACC Wire:** Make sure to connect the ACC wire once you have power connected so the light will work properly.
It can be connected to the ignition or headlight position of the motorcycle.



ACC refers to the accessory power option, allowing you to connect the switch panel to either the ACC (accessory) or the battery for power.

- **Overtaking & Horn Wires:** Connect the **overtaking wire** to the high/low beam toggle switch on your handlebar.
Connect the **horn wire** to the horn circuit.





If you don't wish to use the horn and passing flash features, you can leave these wires unconnected. It won't affect the other functions.

● Switch Button Instructions:

① 3-button Switch (White/Amber DRL)

-  Button: 1st press-Low beam (4 LEDs on)
2nd press-High beam (all 9 LEDs on)
-  Button: Controls the amber/white DRL.
-  Button: Activates the sync strobe or left/right strobe.

② 4-button Switch (White & Amber DRL)

-  Button: 1st press-Low beam (4 LEDs on)
2nd press-High beam (all 9 LEDs on)
-  Button: 1st press-White DRL
2nd press-Amber DRL
-  Button: Activates the sync strobe or left/right strobe.
-  Button: Brightness adjustable (100/80/60/40%) for both low/high beam and flash modes.

Ride safe and enjoy your upgraded visibility with the D09 Pro!



Visit us on www.led-colight.com for your offroad needs.
For any additional assistance or inquiries, feel free to contact our customer support at support@led-colight.com